

“Stay Connected” with



Liquid Tight Conduit, Tubing & Fittings

a PennEngineering® Company

Heyco-Flex™ Zinc Die-Cast Liquid Tight Conduit Fittings

For use with Nonmetallic Heyco-Flex™ I Electrical Conduit
Straight-Thru, NPT Hubs



FITS CONDUIT/TUBING TRADE SIZE	PART NO.	DESCRIPTION	PART DIMENSIONS BODY AND SEALING UNIT									
			A Clearance Hole		B Max. O.A. Length		C Thread Length		D Wrenching Nut Thk.		E Flat Size	
			in.	mm.	in.	mm.	in.	mm.	in.	mm.	in.	mm.
NEW! 3/8	9786	HFC-Z 3/8	.890	22,6	1.27	32,3	.49	12,3	.16	4,1	1.19	30,1
1/2	9794	HFC-Z 1/2	.890	22,6	1.27	32,3	.49	12,3	.16	4,1	1.19	30,1
3/4	9795	HFC-Z 3/4	1.109	28,1	1.37	34,8	.50	12,6	.19	4,7	1.50	38,1
1	9793	HFC-Z 1	1.375	34,9	1.67	42,4	.58	14,7	.16	4,1	1.69	42,9
NEW! 1-1/4	9787	HFC-Z 1-1/4	1.734	44,0	2.06	52,3	.61	15,5	.20	4,1	1.73	44,0
NEW! 1-1/2	9788	HFC-Z 1-1/2	1.984	50,4	2.09	53,0	.63	16,0	.21	5,2	2.20	55,9
NEW! 2	9789	HFC-Z 2	2.469	62,7	2.15	54,6	.63	16,0	.21	5,2	3.03	76,9

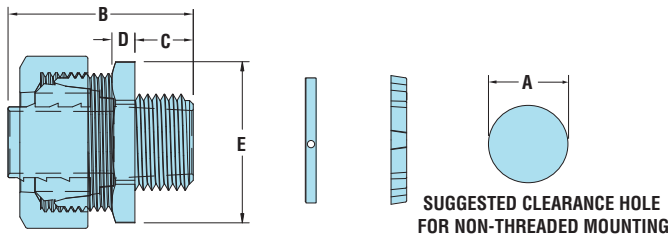

- Cost effective die-cast zinc construction provides durability and resists rough environments.
- Liquid Tight when used with Heyco-Flex™ I Liquid Tight Conduit. See Page 2-7.
- Provide smooth connection, no sharp edges to strip wire.
- Suitable for outside, inside, and industrial uses including transformer connections, air conditioning, and heating.
- Suitable for use in both wet and dry location.
- Fit the most common sizes of nonmetallic liquid tight conduit.
- If using a tapped hole, Teflon® tape is needed on the threads of the connector, for all other applications an O-ring and Locknut are needed to attain liquid tight.
- Supplied with locknut and plastic sealing ring.
- DFARS Compliant

90° Sweep, NPT Hubs

FITS CONDUIT/TUBING TRADE SIZE	PART NO.	DESCRIPTION	PART DIMENSIONS BODY AND SEALING UNIT											
			A Clearance Hole		B Max. O.A. Length		C Max. O.A. Height		D Thread Length		E Wrenching Nut Thk.		F Flat Size	
			in.	mm.	in.	mm.	in.	mm.	in.	mm.	in.	mm.	in.	mm.
NEW! 3/8	9790	HFC-Z 3/8-90	.890	22,6	2.53	76,9	2.11	53,6	.53	13,5	.16	4,1	1.19	30,1
1/2	9796	HFC-Z 1/2-90	.890	22,6	2.46	62,5	2.24	56,9	.53	13,5	.16	4,1	1.19	30,1
NEW! 3/4	9797	HFC-Z 3/4-90	1.109	28,1	2.79	70,9	2.47	62,5	.55	14,0	.19	4,7	1.50	38,1
NEW! 1	9791	HFC-Z 1-90	1.375	34,9	3.86	98,0	3.46	87,9	.58	14,7	.16	4,1	1.69	42,9
NEW! 1-1/4	9792	HFC-Z 1-1/4-90	1.734	44,0	3.99	101,3	3.37	85,6	.67	9,4	.20	4,1	1.73	44,0
NEW! 1-1/2	9798	HFC-Z 1-1/2-90	1.984	50,4	5.04	128,0	4.28	108,7	.61	15,5	.21	5,2	2.20	55,9
NEW! 2	9799	HFC-Z 2-90	2.469	62,7	5.06	128,5	4.21	106,9	.71	18,0	.21	5,4	3.03	76,9

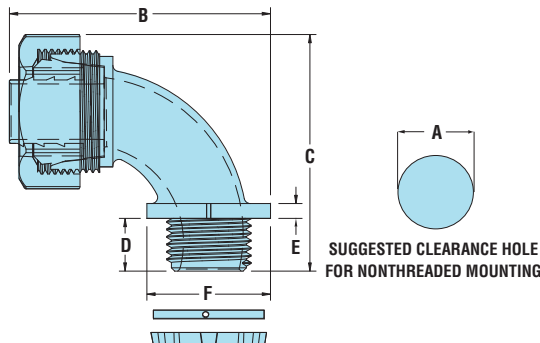

Material
Certifications

Die cast zinc
Listed under UL File E28430



Quick
Specs